

PROJET :  
**Bâtiment stockage oignons - 72.6m<sup>2</sup>**

DESSIN :  
**Plan d'aménagement**

DAO :

**SR**

DATE :

**21-03-2019**

ECHELLE :

**1 : 100**

PAGE :

**01**

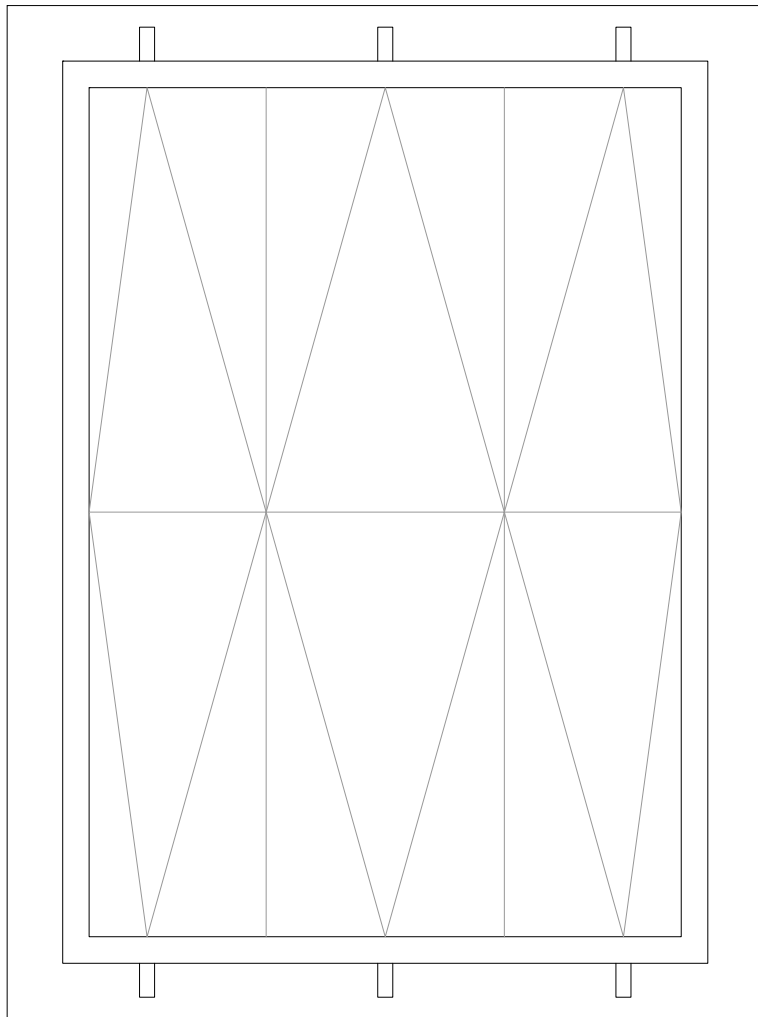

PROJET :  
**Bâtiment stockage oignons - 72.6m<sup>2</sup>**

DESSIN :  
**Plan de toiture**

DAO :  
**SR**

DATE :  
**21-03-2019**

ECHELLE :  
**1 : 100**

PAGE :

**02**

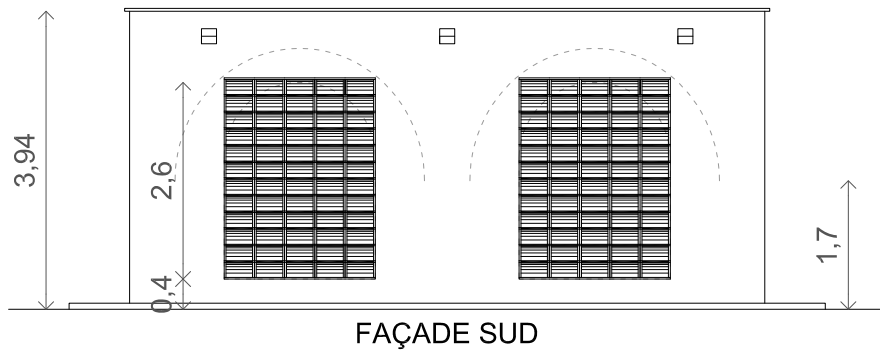
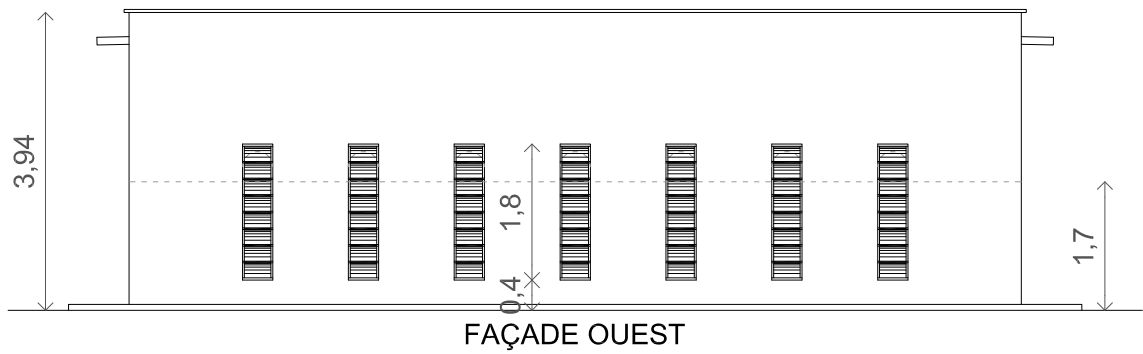
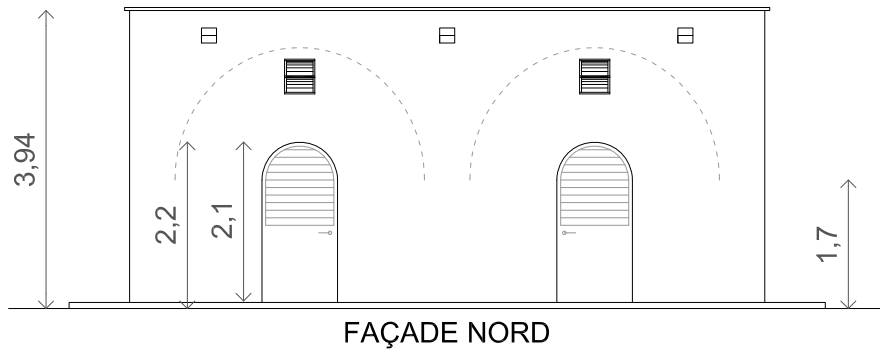

	PROJET : <b>Bâtiment stockage oignons - 72.6m2</b>	DAO : <b>SR</b>	PAGE : <b>03</b>
	DESSIN : <b>Façades</b>	DATE : <b>21-03-2019</b>	
		ECHELLE : <b>1 : 100</b>	

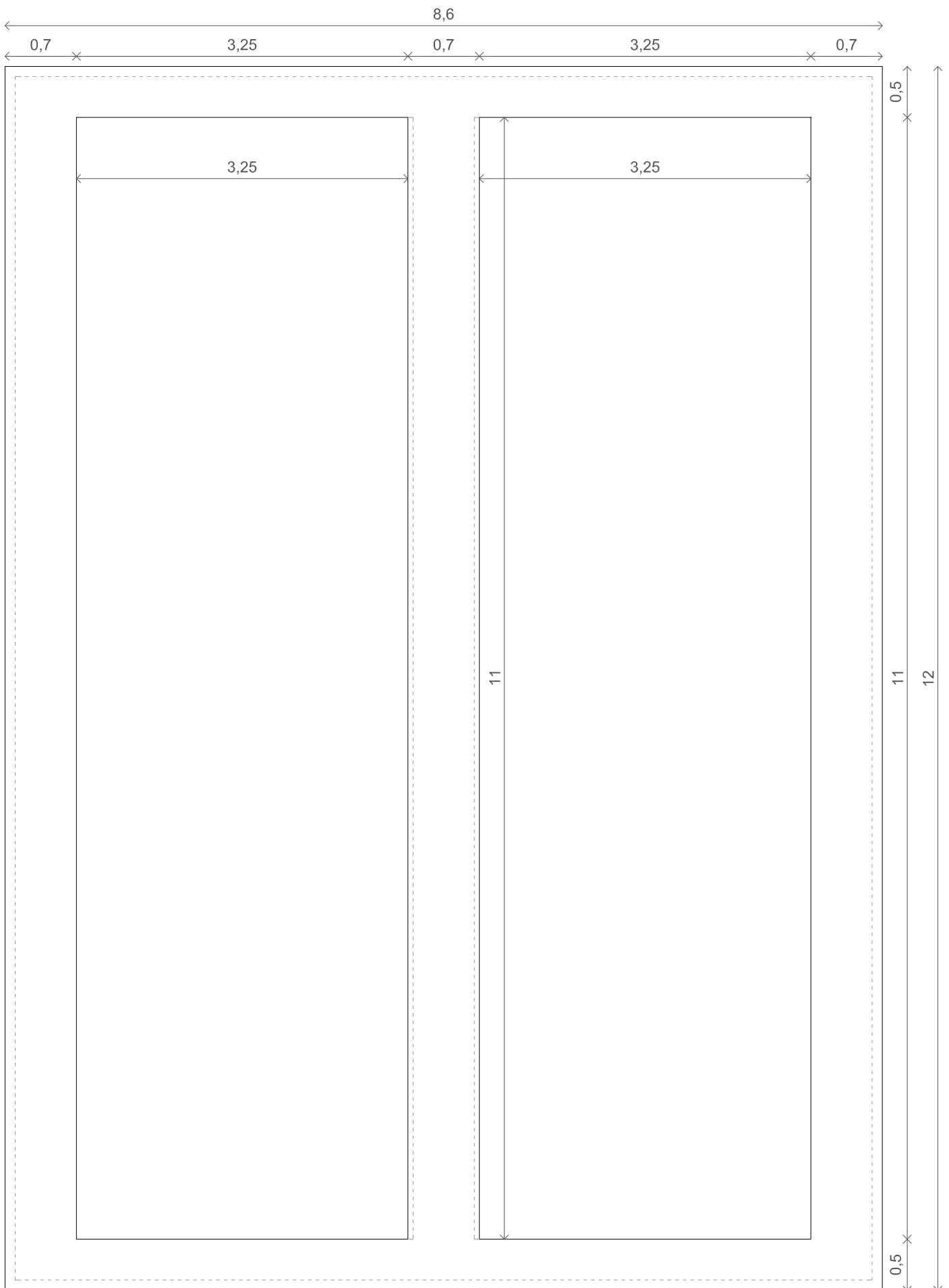

PROJET : **Bâtiment stockage oignons - 72.6m<sup>2</sup>**

DESSIN : **Plan de fondation**

DAO : **SR**

DATE : **21-03-2019**

ECHELLE : **1 : 50**

PAGE :

**04**

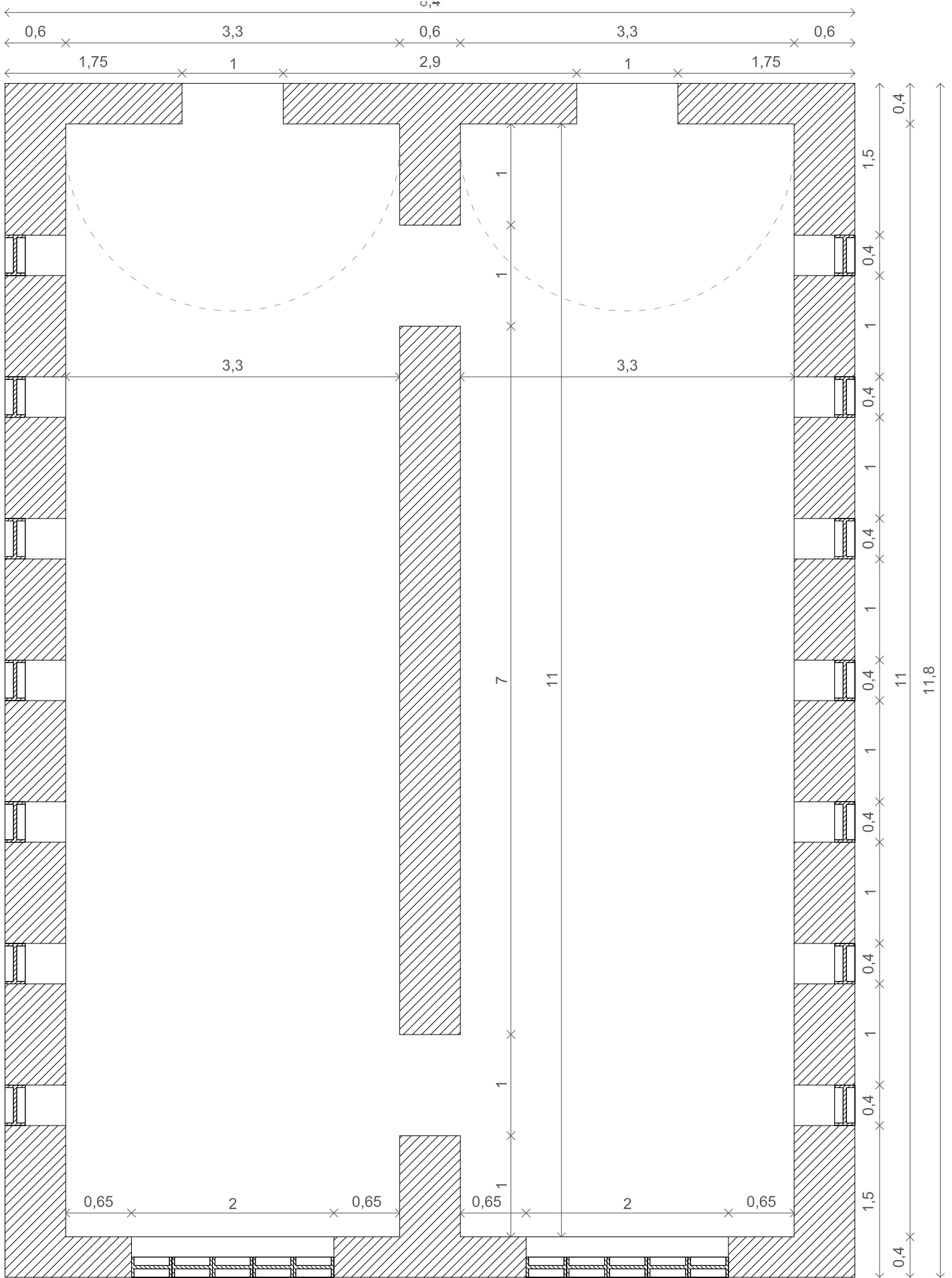

PROJET : **Bâtiment stockage oignons - 72.6m2**

DESSIN : **Plan**

DAO : **SR**

DATE : **21-03-2019**

ECHELLE : **1 : 50**

PAGE : **05**

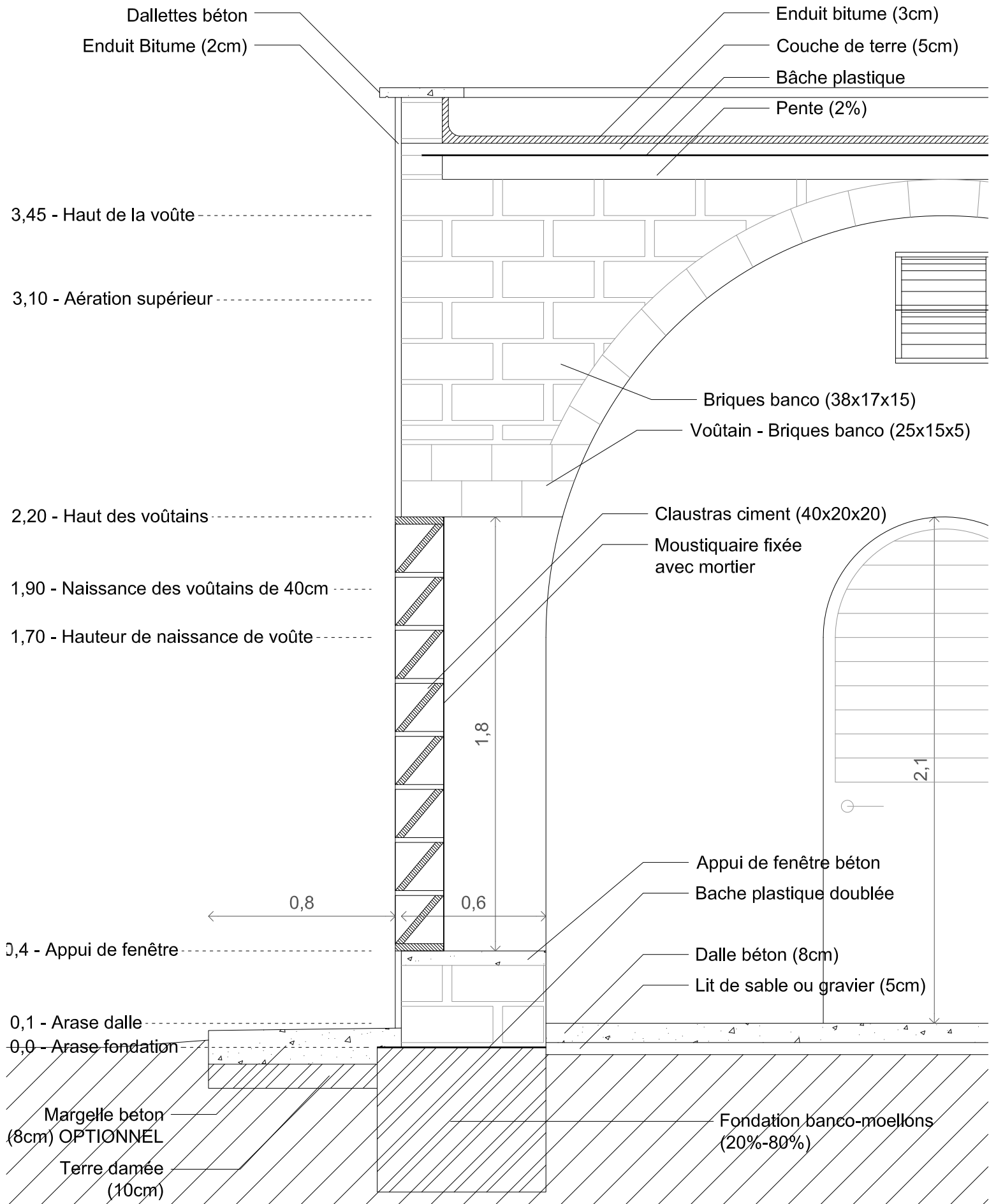

	PROJET :	Bâtiment stockage oignons - 72.6m <sup>2</sup>	DAO :	SR	PAGE :	06
	DESSIN :	Section détaillée A	DATE :	21-03-2019		
			ECHELLE :	1 : 20		

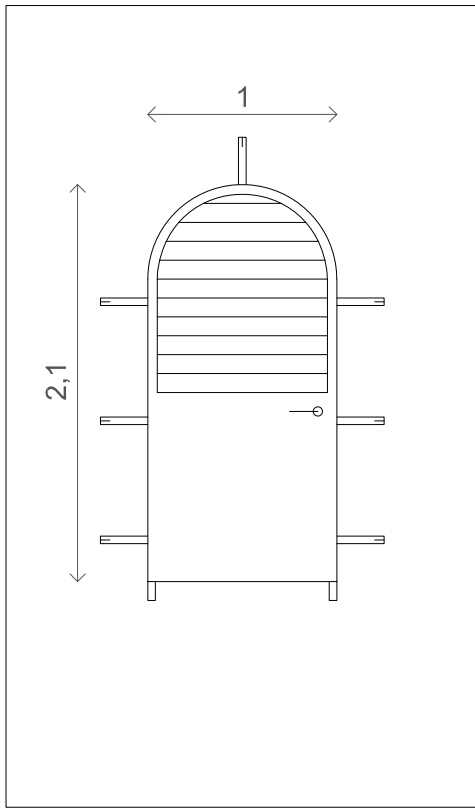

PORTE (X2)

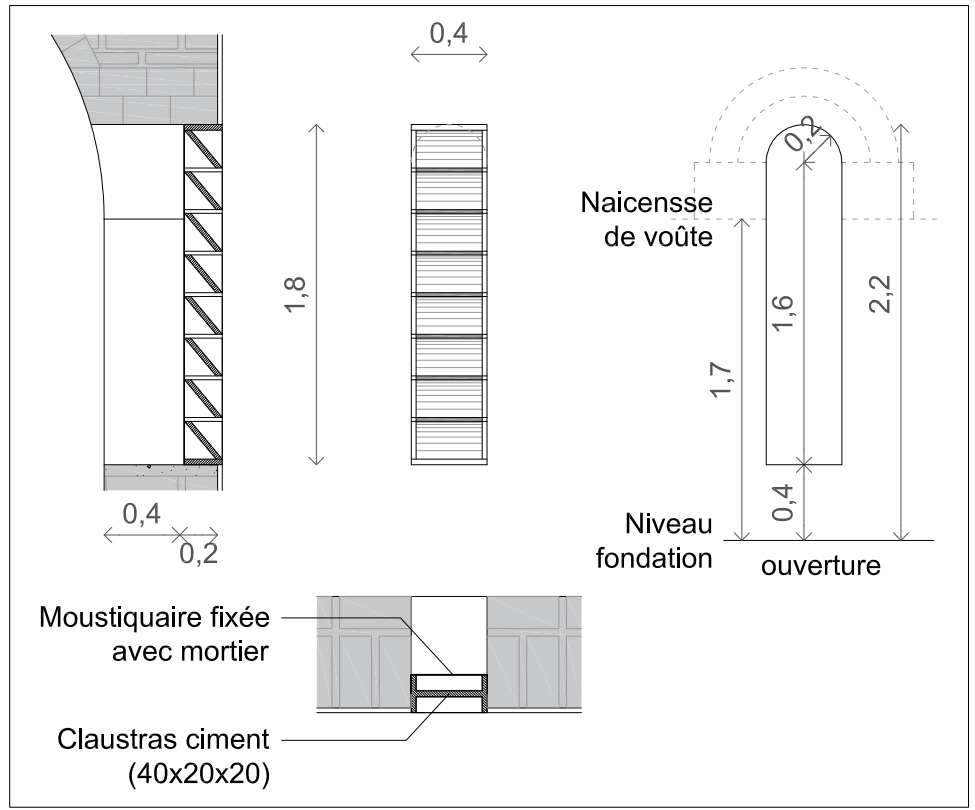

OUVERTURE FAÇADE SUD (X12)

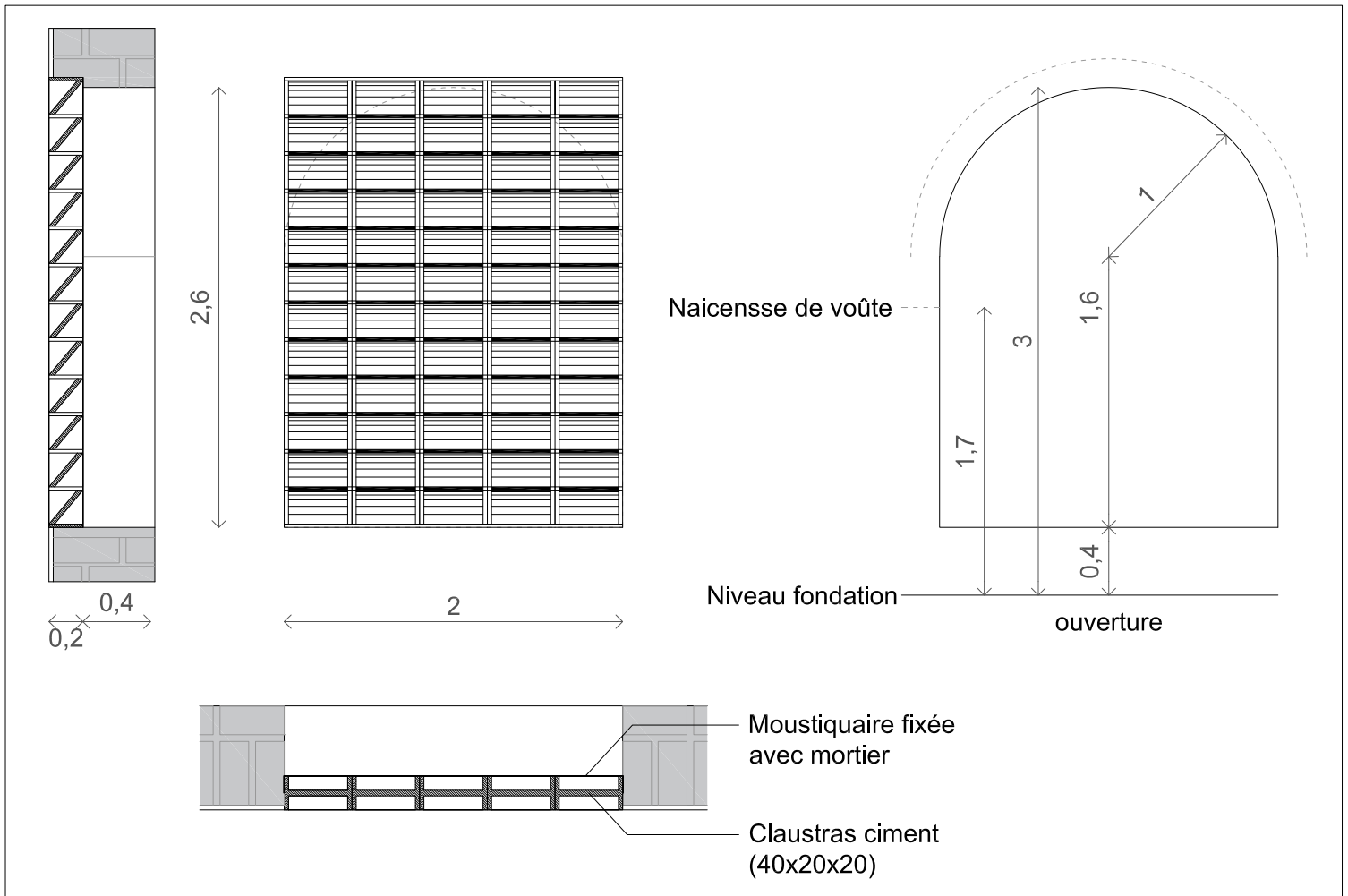

OUVERTURE FAÇADES EST ET OUEST (X4)

	PROJET :	Bâtiment stockage oignons - 72.6m2	DAO :	SR	PAGE :	07
	DESSIN :	Ouvertures	DATE :	21-03-2019		
			ECHELLE :	1 : 40		